

ATC GENERAL PURPOSE CAPACITORS: NPO (COG) DIELECTRIC

ELECTRICAL CHARACTERISTICS

CAPACITANCE RANGE: 0.5 pF to 0.10 μ F.

TEMPERATURE CHARACTERISTIC: $0 \pm 30\text{ppm}/^\circ\text{C}$.

OPERATING TEMPERATURE RANGE: -55°C to $+125^\circ\text{C}$.

DISSIPATION FACTOR:

0.1% (max.) @ $+25^\circ\text{C}$,

@1 MHz ≤ 1000 pF; @1 KHz >1000 pF

INSULATION RESISTANCE @ $+25^\circ\text{C}$ and rated Vdc:

100,000 megohms (min.) or 1000 ohm-farads (min.),

whichever is less.

DIELECTRIC WITHSTANDING VOLTAGE:

250% of rated voltage for 5 ± 1 seconds, 50 milliamps (max.).

Unless otherwise specified all test data is at $+25^\circ\text{C}$.

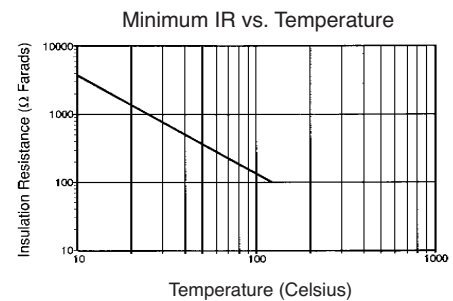
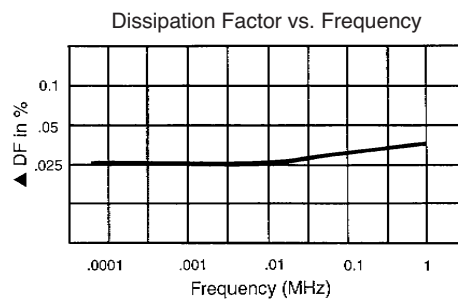
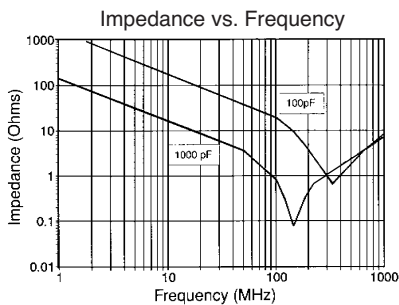
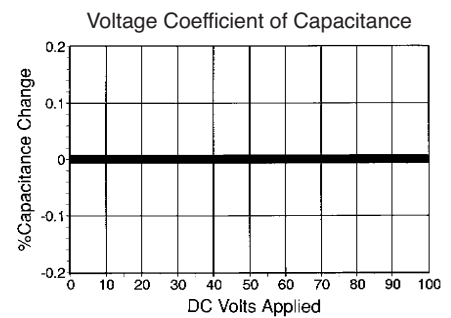
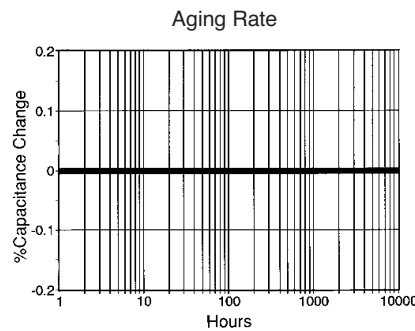
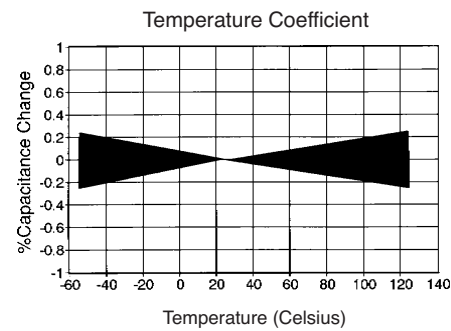
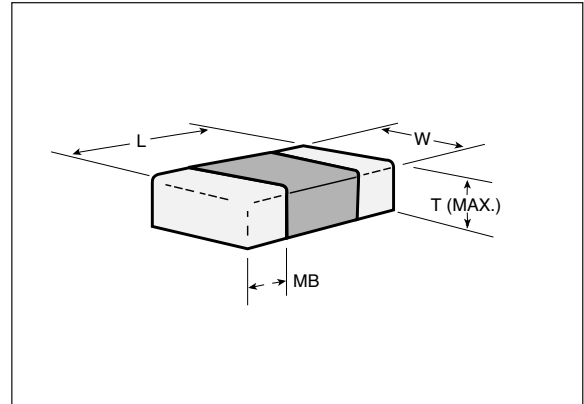

Sales of ATC products are subject to the terms and conditions contained in American Technical Ceramics Corp. Terms and Conditions of Sale(ATC document #001-992 Rev. A 10/03). Copies of these terms and conditions will be provided upon request. They may also be viewed on ATC's website at www.atceramics.com/productfinder/default.asp. Click on the link for Terms and Conditions of Sale.

ATC has made every effort to have this information as accurate as possible. However, no responsibility is assumed by ATC for its use, nor for any infringements of rights of third parties which may result from its use. ATC reserves the right to revise the content or modify its product without prior notice.

© 1997 American Technical Ceramics. All Rights Reserved.

A M E R I C A N T E C H N I C A L C E R A M I C S

ATC North America
631-622-4700 sales@atceramics.com

ATC Europe
+46 8 6800410 sales@atceramics-europe.com

ATC Asia
86-755-8366-4318 sales@atceramics-asia.com

ATC GENERAL PURPOSE CAPACITORS: NPO (COG) DIELECTRIC

SIZE	0402	0504	0603	0805	1206	1210	1812	2225*
Length (L)	.040 (1.02)	.050 (1.27)	.063 (1.60)	.079 (2.00)	.126 (3.20)	.126 (3.20)	.177 (4.50)	.220 (5.59)
Width (W)	.020 (0.51)	.040 (1.02)	.031 (0.80)	.049 (1.25)	.063 (1.60)	.098 (2.50)	.126 (3.20)	.250 (6.35)
Tol. L & W	±.004 (0.10)	±.006 (.152)	±.005 (0.12)	±.008 (0.2)	±.008 (0.2)	±.008 (0.2)	±.010 (0.25)	±.015 (0.38)
T Max.	.025 (0.64)	.044 (1.12)	.035 (0.89)	.051 (1.30)	.051 (1.30)	.067 (1.70)	.067 (1.70)	.070 (1.78)
Term. (MB) Min.	.004 (.10)	.005 (.12)	.005 (.12)	.010 (.25)	.010 (.25)	.010 (.25)	.010 (.25)	.010 (.25)
Max.	.012 (.30)	.015 (.38)	.015 (.38)	.028 (.71)	.028 (.71)	.028 (.71)	.030 (.76)	.030 (.76)
Min. Cap.	0R5	0R5	0R5	0R5	0R5	681	471	102
Max. Cap. (code) & WVDC								
10V								
16V	271	182	102	103	153	273	393	104
25V	331	122	102	472	223	223	393	104
50V	221	102	102	332	103	223	333	104
100V	101	561	102	182	562	103	183	683
200V	680	391	271	122	392	822	123	473
500V				471	102	222	392	153
1000V				331	821	182	222	103
2000V					271	681	122	472
5000V								

Dimensions shown in inches (mm)

Higher voltages available upon request.

* IR and Vapor Phase soldering only recommended.

PART NUMBER CODE

Size Code: 0603

Temperature Characteristic: NPO

Capacitance Code: First 2 Significant Digits For Capacity: 1R

Indicates number of zeros following digits of capacitance in picofarads: 0

R=Decimal Point: C

Termination Code: I

WVDC Code: 2

Marking: A=No mark

*S=EIA Code - *Special Order

Packaging: T=7" Reel, B=Bulk
*R=13" Reel - *Special Order

WVDC Code	A	7	1	2	3	4	5	6	8	9
WVDC	10	16	25	50	100*	200*	500*	1000*	2000*	5000*

*Special Order - Consult Factory

CAPACITANCE TOLERANCE				
Code	B*	C	G*	J
Tol.	±0.1	±0.25	±2	±5
	pF (Values < 10 pF)		% (Values > 10 pF)	

*Tighter tolerances available.

Termination Code
T = Tin plated over Nickel Barrier (Standard), RoHS Compliant
W = Tin/Lead, Solder Plated over Nickel Barrier**
C = Palladium Silver, (non-magnetic), RoHS Compliant**
**Consult ATC for availability

STANDARD EIA CAPACITANCE VALUES REFERENCE TABLE

Cap. Code	Cap. pF	Cap. Code	Cap. pF	Cap. Code	Cap. pF	Cap. Code	Cap. pF	Cap. Code	Cap. pF	Cap. Code	Cap. pF	Cap. Code	Cap. pF	Cap. Code	Cap. pF
0R5	0.5	6R8	6.8	560	56	471	470	392	3900	273	.027	224	.22	185	1.8
1R0	1.0	8R2	8.2	680	68	561	560	472	4700	333	.033	274	.27	225	2.2
1R2	1.2	100	10	820	82	681	680	562	5600	393	.039	334	.33	275	2.7
1R5	1.5	120	12	101	100	821	820	682	6800	473	.047	394	.39	335	3.3
1R8	1.8	150	15	121	120	102	1000	822	8200	563	.056	474	.47	395	3.9
2R2	2.2	180	18	151	150	122	1200			683	.068	564	.56	475	4.7
2R7	2.7	220	22	181	180	152	1500	Cap. Code	Cap. pF	823	.082	684	.68	565	5.6
3R3	3.3	270	27	221	220	182	1800	103	.010	823	.082	684	.68	565	5.6
3R9	3.9	330	33	271	270	222	2200	123	.012	104	.10	824	.82	685	6.8
4R7	4.7	390	39	331	330	272	2700	153	.015	124	.12	105	1.0	825	8.2
5R6	5.6	470	47	391	390	332	3300	183	.018	154	.15	125	1.2	106	10.0
								223	.022	184	.18	155	1.5	126	12.0
														156	15.0

A M E R I C A N T E C H N I C A L C E R A M I C S

ATC North America
631-622-4700 sales@atceramics.com

ATC Europe
+46 8 6800410 sales@atceramics-europe.com

ATC Asia
86-755-8366-4318 sales@atceramics-asia.com